

DATASHEET TECHNICAL SPECIFICATIONS

<https://www.kon-tec.eu/>

LITHIUM IRON PHOSPHATE LiFePO₄ BATTERY

12,8 V 200 Ah

KT-LFP12200



1. BATTERY PARAMETERS

HIGHLIGHTS

- Kon-TEC batteries are **1/3 lighter and provide more power output** than conventional lead-acid, gel or AGM batteries
- **Fast charging, with low energy loss.** High energy efficiency is ensured by very high efficiency (approx. 99%).
- **100% current independent of the degree of discharge.** In the case of lead-acid batteries are no more than 60% of the declared capacity.
- **Very high durability - 2000 cycles (full charge and discharge) or more.**
In comparison, a lead-acid battery typically lasts only approx. 200-300 cycles.
- **Performance gain.** LiFePO₄ battery life exhibits a 2x lower cost of energy given up compared to GEL batteries.

Read more at www.kon-tec.eu/why-li-ion/

APPLICATION

- ELECTRIC VEHICLES AND APPLIANCES,
- CAMPERS,
- OUTBOARD MOTORS,
- BOATS, YACHTS AND HOUSEBOATS,
- PHOTOVOLTAICS
- WIND TURBINES,
- EMERGENCY LIGHTING,
- 12V APPLIANCES AND TOYS,
- POWER SOURCE FOR 12V-/230 INVERTERS

BATTERY LIFE AT CYCLIC OPERATION

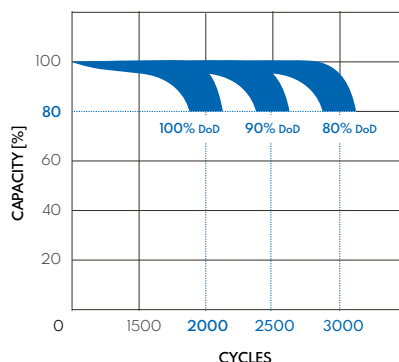

DIMENSIONS

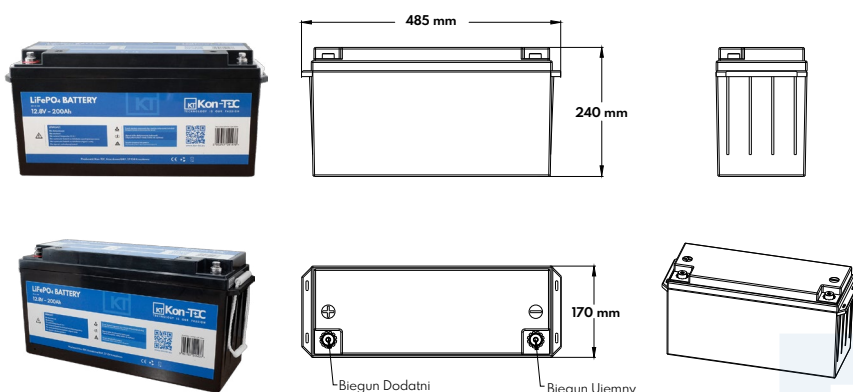

VOLTAGE AND CAPACITY

Nominal voltage	12.8V
Average voltage	13.2V±0.1V (C/20)
Nominal capacity	200Ah
Energy	2560Wh

CHARGE AND DISCHARGE

Recommended charge voltage	14.6±0.2V
Maximum charge current	200A
Recommended charge current	≤ 100A
BMS Charge voltage cut off	15V (3.75V per cell)
Balancing voltage	14.4V (3.6V per cell)
Charge method	CC/CV
Charge time	10A - 20h / 20A - 10h
Maximum continuous discharge current	200A
Pulse discharge current	400A(3s)
BMS Discharge current cut-off	L1: 220A(6ms) L2: 400A(0.5s)
Recommended low voltage disconnect	9.6-11V
BMS Discharge voltage cut-off	10V
Reconnect voltage	11V
Short circuit protection	400µs

OPERATING CONDITIONS

Operating temperature	-20°C-60°C
Charging temperature	0°C-45°C
Storage temperature	-20°C-60°C
BMS High temperature cut-off	65°C
Reconnect temperature	50°C

OTHER

Lifetime	100% DoD (2000 cycles)
Dimensions	485x170x240mm
Weight	23.8 kg
Terminal type	M8
Cell amount	4
Cell configuration	4S1P
Efficiency	99%
Self-discharge	<4% per month

COMPLIANCE

Certification	CE
---------------	----

The battery contains built in battery management system BMS.

PROTECTION TYPE

- Overcharge,
- Over discharge,
- Short circuit,
- High temperatures,
- Charging in low temperatures,
- Passive balancing of cells

2. PERFORMANCE CHARACTERISTICS

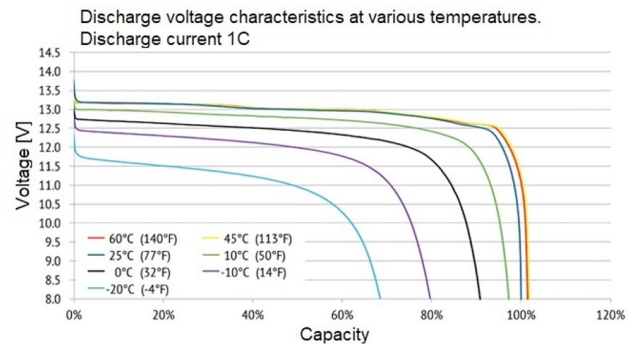
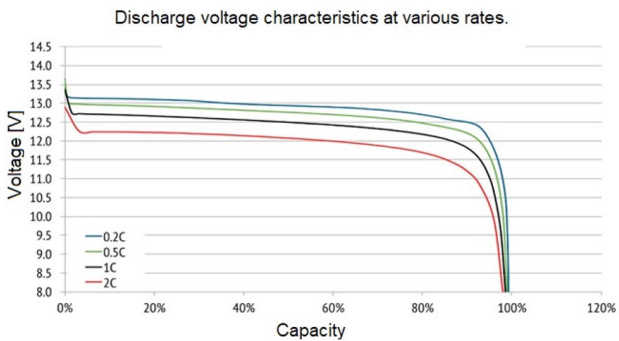
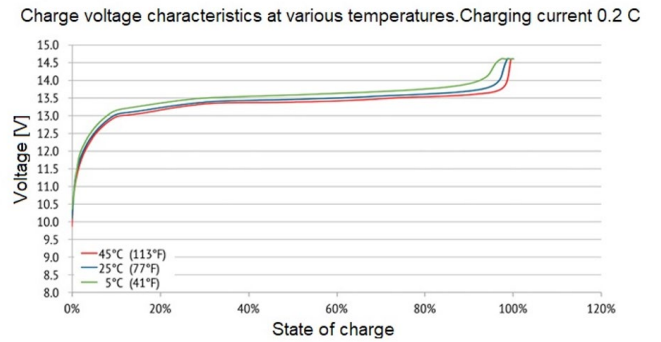
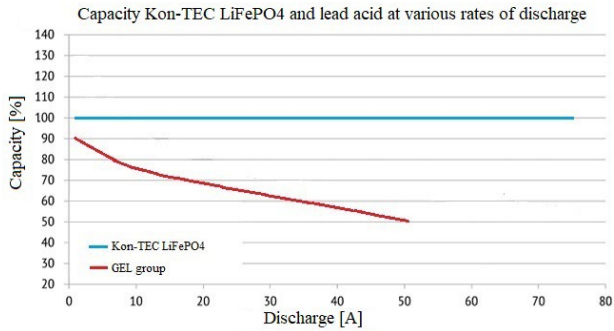
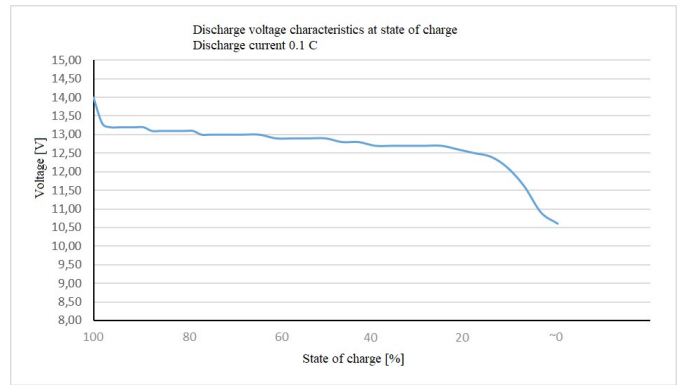
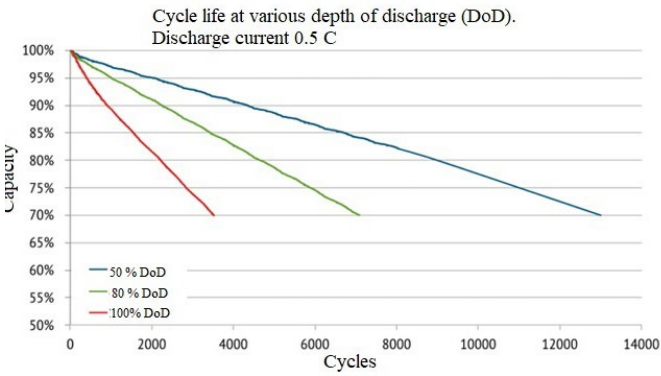
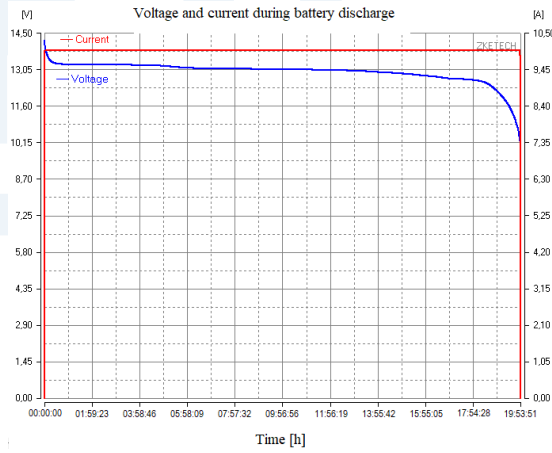

RESTRICTIONS

- Read operating manual before use.
- Never short circuit positive (+) and negative pole (-) of battery.
- Do not: cut, unscrew, throw, disassemble battery.
- Do not store the battery with metal objects or other conductive objects.
- Do not expose the battery to high temperatures, sunlight, water and fire.
- The battery is not suitable for use in vehicles as primary power source (start).
- It is forbidden to connect different types of batteries.
- Use only dedicated charger for LiFePO4 batteries
- It is not allowed to charge the battery at temperatures below 0 °C.

STORAGE

- Store in dry place with a temperature range -20~+60 st °C / <1 month, -10~+45 st °C / >3 months.
 - Store the battery in the state of 50 % charge (longer lifetime).
- The cycle amount depends on the state of discharge. It is no less than 2,000 while maintaining 100% DoD (depth of discharge). The lower discharge cycles, the longer lifetime of battery. After 2,000 cycles the battery is still efficient, although its capacity decreases over time.
- The estimated battery life is assumed to be over 12 years.

TERMS OF WARRANTY

Kon-TEC will provide the following warranty to the original purchaser subject 12.8V LFP battery, to the terms and conditions stated herein.

The customer is guaranteed that this product will be free from defects in materials and production for a period of 2 years.

If during the warranty period there are symptoms that may indicate a product defect, the client is obligated to contact the technical support department for further action.

Under this warranty, a defective product will be replaced or put back into service.

THIS WARRANTY DOES NOT APPLY

- In case of modifying, opening, changing or damage of the product due to improper use.
- In case of non-compliance with the following operating manual.
- If the product is sold at a public auction.
- In case of damage to the device during an accident or natural disaster.
- In case of damage to the connection terminals.
- In case of improper connection, use or charging the device.
- In case of damage to the device by fire, freezing or high temperature.
- In case of flooding/crushing by pressure.
- In case of user interference in the device.
- In case of damage to the case.